

## MESA COM BANCOS EM MEIOS TRONCOS

### REFERÊNCIA

2111

### PESO

90 Kilos

### MATERIAL

Pinho Nacional

### TRATAMENTO

Autoclave, tratamento castanho, classe de risco 4



### VISTA LATERAL

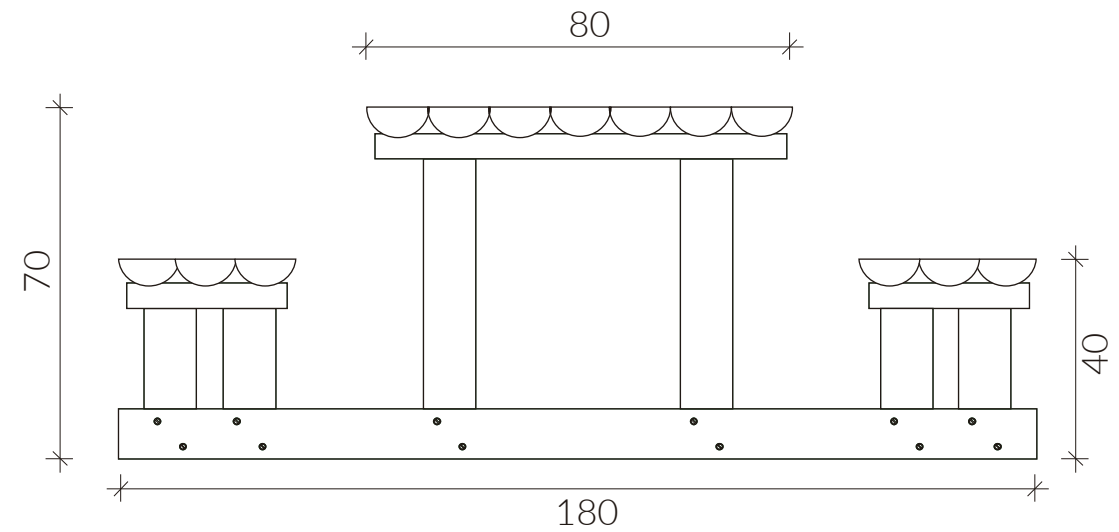

Comprimento tampo: 245 cm